

Work, Energy and EMF

Single-Loop Circuits

Multi-Loop Circuits

RC Circuits

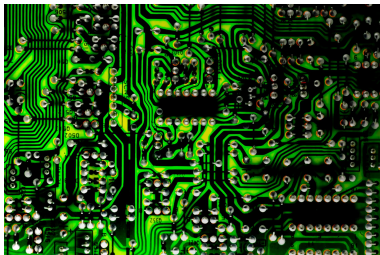

“Invention is the most important product of man’s creative brain. The ultimate purpose is the complete mastery of mind over the material world, the harnessing of human nature to human needs.”

- Nikola Tesla

David J. Starling
Penn State Hazleton
PHYS 212

A battery does work on charge in a circuit.

- ▶ How much work does it do, per charge?
- ▶ This is called the *electromotive force*, or **emf**.
- ▶ Definition:

$$\mathcal{E} = \frac{dW}{dq} \quad (1)$$

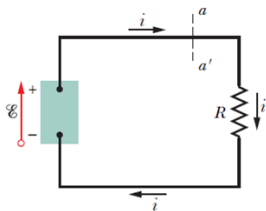

- ▶ Examples: batteries, generators, solar cells, fuel cells (H), electric eels, human nervous system

Let's look at the energy in this circuit:

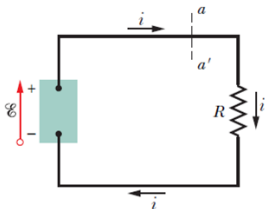

- ▶ The battery does work: $dW = \mathcal{E}dq$
- ▶ The resistor dissipate energy: $Pdt = i^2Rdt$
- ▶ Recall the definition of current: $dq = idt$

Work, Energy and EMF

Single-Loop Circuits

Multi-Loop Circuits

RC Circuits

Let's look at the energy in this circuit:

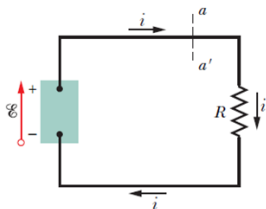

► Putting this together:

$$dW = P dt \text{ (conservation of energy)}$$

$$\mathcal{E} dq = i^2 R dt$$

$$\mathcal{E} i = i^2 R$$

$$\mathcal{E} = iR$$

The emf \mathcal{E} of an emf device is the potential V that it produces.

Work, Energy and EMF

Single-Loop Circuits

Multi-Loop Circuits

RC Circuits

Lecture Question 10.1:

Consider a circuit that contains an ideal battery and a resistor to form a complete circuit. Which one of the following statements concerning the work done by the battery is true?

- (a) No work is done by the battery in such a circuit.
- (b) The work done is equal to the thermal energy dissipated by the resistor.
- (c) The work done is equal to the work needed to move a single charge from one side of the battery to the other.
- (d) The work done is equal to the emf of the battery.
- (e) The work done is equal to the product iR .

A few rules to remember:

- ▶ **Resistance Rule:** the potential drops by iR across a resistor in the direction of the current; the potential *increases* by iR in the opposite direction.
- ▶ **Emf Rule:** the potential increases by \mathcal{E} from the negative to the positive terminal, regardless of the direction of current.
- ▶ **Loop Rule:** the sum of the changes in potential encountered in a complete traversal of any loop of a circuit must be zero.
- ▶ **Junction Rule:** the sum of the currents entering a junction equals the sum of the currents leaving that junction.

Work, Energy and EMF

Single-Loop Circuits

Multi-Loop Circuits

RC Circuits

Resistance Rule

- ▶ The potential drops by iR across a resistor in the direction of the current; the potential *increases* by iR in the opposite direction.

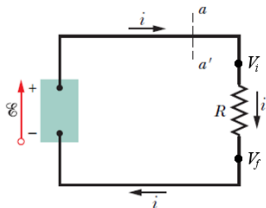

- ▶ $V_f - V_i = -iR$
- ▶ $\Delta V = -iR$
- ▶ Or, $V_i - V_f = +iR$ (against the current)

Emf Rule

- ▶ The potential increases by \mathcal{E} from the negative to the positive terminal, regardless of the direction of current.

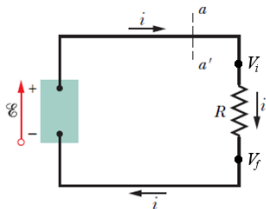

- ▶ The roles of V_i and V_f have switched.
- ▶ $V_i - V_f = \mathcal{E}$

Loop Rule

- ▶ The sum of the changes in potential encountered in a complete traversal of any loop of a circuit must be zero.

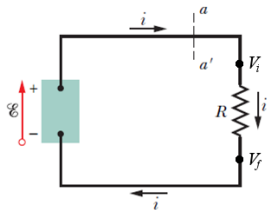

- ▶ Start at V_i and end at V_i :
- ▶ $V_i - iR + \mathcal{E} = V_i$
- ▶ Opposite direction: $V_i - \mathcal{E} + iR = V_i$.
- ▶ Both equations: $\mathcal{E} - iR = 0$

Junction Rule

- ▶ The sum of the currents entering a junction equals the sum of the currents leaving that junction.

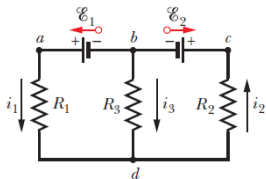

- ▶ For junction b : $i_2 = i_1 + i_3$
- ▶ For junction d : $i_1 + i_3 = i_2$

Let's look at a "real" battery:

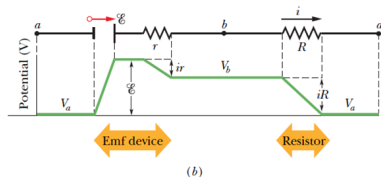
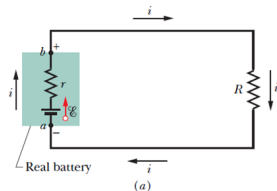

- ▶ Most batteries have some internal resistance r .
- ▶ This resistance makes the battery voltage seem smaller than the emf \mathcal{E} .
- ▶ The larger the current, the worse the effect.

Work, Energy and EMF

Single-Loop Circuits

Multi-Loop Circuits

RC Circuits

Let's look at a "real" battery:

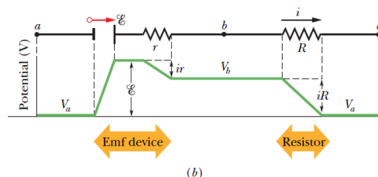
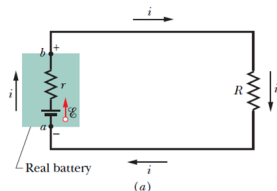

► Let's sum up the changes:

$$\begin{aligned}\mathcal{E} - ir - iR &= 0 \\ i &= \frac{\mathcal{E}}{r + R}\end{aligned}$$

Work, Energy and EMF

Single-Loop Circuits

Multi-Loop Circuits

RC Circuits

Another example:

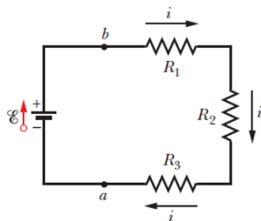

- Let's sum up the changes:

$$\mathcal{E} - iR_1 - iR_2 - iR_3 = 0$$
$$i = \frac{\mathcal{E}}{R_1 + R_2 + R_3}$$

This is the same if we replace all three series resistors with $R_{eq} = R_1 + R_2 + R_3$.

Work, Energy and EMF

Single-Loop Circuits

Multi-Loop Circuits

RC Circuits

For resistors in *series*:

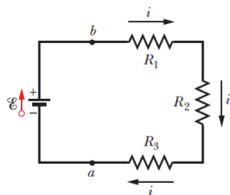

We replace them with an equivalent resistance:

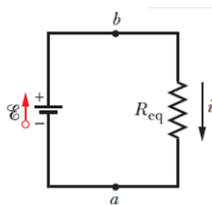

$$R_{eq} = R_1 + R_2 + R_3 = \sum_{i=1}^3 R_i \quad (2)$$

Work, Energy and EMF

Single-Loop Circuits

Multi-Loop Circuits

RC Circuits

Lecture Question 10.2

Which resistors, if any, are connected in series?

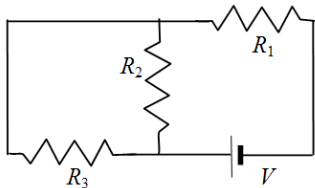

- (a) R_1 and R_2
- (b) R_1 and R_3
- (c) R_2 and R_3
- (d) R_1 , R_2 and R_3
- (e) None

Work, Energy and EMF

Single-Loop Circuits

Multi-Loop Circuits

RC Circuits

Three parallel resistors:

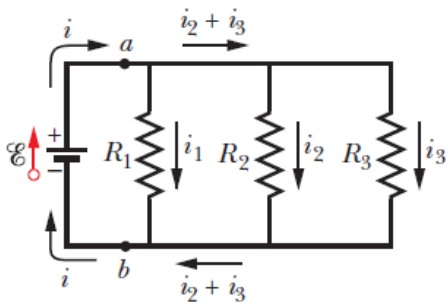

- ▶ Resistors in parallel all have the same voltage V
- ▶ But they may have different currents
- ▶ In this example, $i = i_1 + i_2 + i_3$

Work, Energy and EMF

Single-Loop Circuits

Multi-Loop Circuits

RC Circuits

Three parallel resistors:

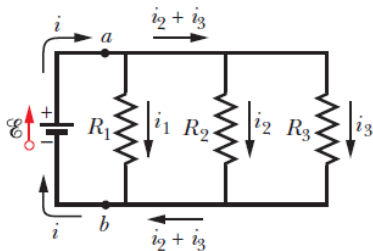

- ▶ Each current is given by $i_1 = V/R_1$
- ▶ This gives:

$$i = i_1 + i_2 + i_3 = \frac{V}{R_1} + \frac{V}{R_2} + \frac{V}{R_3} = V \left(\frac{1}{R_1} + \frac{1}{R_2} + \frac{1}{R_3} \right)$$

Work, Energy and EMF

Single-Loop Circuits

Multi-Loop Circuits

RC Circuits

Multi-Loop Circuits

For three parallel resistors, we can use an equivalent resistance:

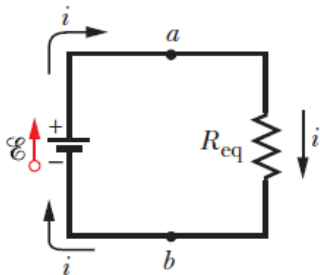

- ▶ such that $V = iR_{eq}$, with

$$\frac{1}{R_{eq}} = \frac{1}{R_1} + \frac{1}{R_2} + \frac{1}{R_3}$$

Work, Energy and EMF

Single-Loop Circuits

Multi-Loop Circuits

RC Circuits

In summary:

Series

Parallel

Capacitors

$$\frac{1}{C_{\text{eq}}} = \sum_{j=1}^n \frac{1}{C_j}$$

Same charge on all capacitors

$$C_{\text{eq}} = \sum_{j=1}^n C_j$$

Same potential difference across all capacitors

Series

Parallel

Resistors

$$R_{\text{eq}} = \sum_{j=1}^n R_j$$

Same current through all resistors

$$\frac{1}{R_{\text{eq}}} = \sum_{j=1}^n \frac{1}{R_j}$$

Same potential difference across all resistors

Consider a circuit with a resistor and a capacitor

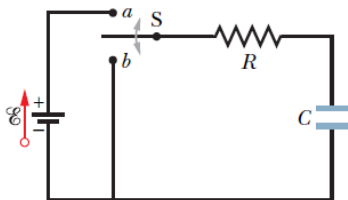

With the battery connected, we find:

- ▶ $\mathcal{E} - iR - q/C = 0$ (loop rule)
- ▶ $i = dq/dt$
- ▶ This gives:

$$R \frac{dq}{dt} + \frac{q}{C} = \mathcal{E}$$

Work, Energy and EMF

Single-Loop Circuits

Multi-Loop Circuits

RC Circuits

Work, Energy and EMF

Single-Loop Circuits

Multi-Loop Circuits

RC Circuits

$$R \frac{dq}{dt} + \frac{q}{C} = \mathcal{E}$$

This is a differential equation

- ▶ The solution, with $q(0) = 0$:

$$q(t) = C\mathcal{E}(1 - e^{-t/RC})$$

- ▶ Don't believe me? Let's check it!
- ▶ Note: $V = q/C = \mathcal{E}(1 - e^{-t/RC})$

The combination $\tau = RC$ is the **capacitive time constant**.

- ▶ If $t = \tau$, then

$$q(\tau) = C\mathcal{E}(1 - e^{-RC/RC}) = 0.63C\mathcal{E}$$

- ▶ τ is the time it takes for the capacitor to charge about 63%

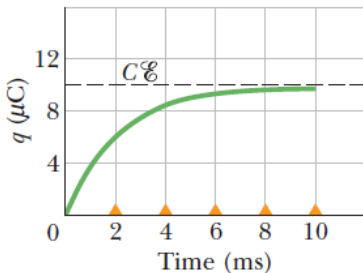

Once the capacitor is charged, let's remove the battery:

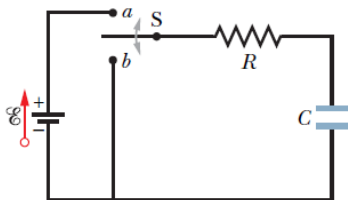

With the battery bypassed, we find:

- ▶ $-iR - q/C = 0$ (loop rule)
- ▶ $i = dq/dt$
- ▶ This gives:

$$R \frac{dq}{dt} + \frac{q}{C} = 0$$

Work, Energy and EMF

Single-Loop Circuits

Multi-Loop Circuits

RC Circuits

$$R \frac{dq}{dt} + \frac{q}{C} = 0$$

- ▶ The solution, with $q(0) = C\mathcal{E}$:

$$q(t) = C\mathcal{E}e^{-t/RC}$$

- ▶ The battery discharges with the same time constant!

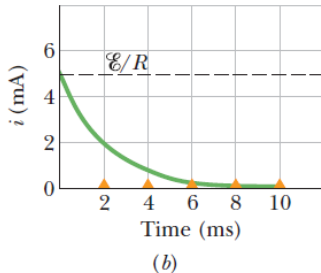

Work, Energy and EMF

Single-Loop Circuits

Multi-Loop Circuits

RC Circuits

Work, Energy and EMF

Single-Loop Circuits

Multi-Loop Circuits

RC Circuits

Lecture Question 10.4

For an RC circuit, how long does it take (in theory) for the capacitor to charge from 0% to 100%?

- (a) 0 s
- (b) 63 s
- (c) RC
- (d) $1 - RC$
- (e) Infinitely long (it never charges completely)